

BALTIMORE CITY FLOODPLAIN PROGRAM

B'more Prepared for Urban Flooding

October 22, 2020



Interjurisdictional Watershed

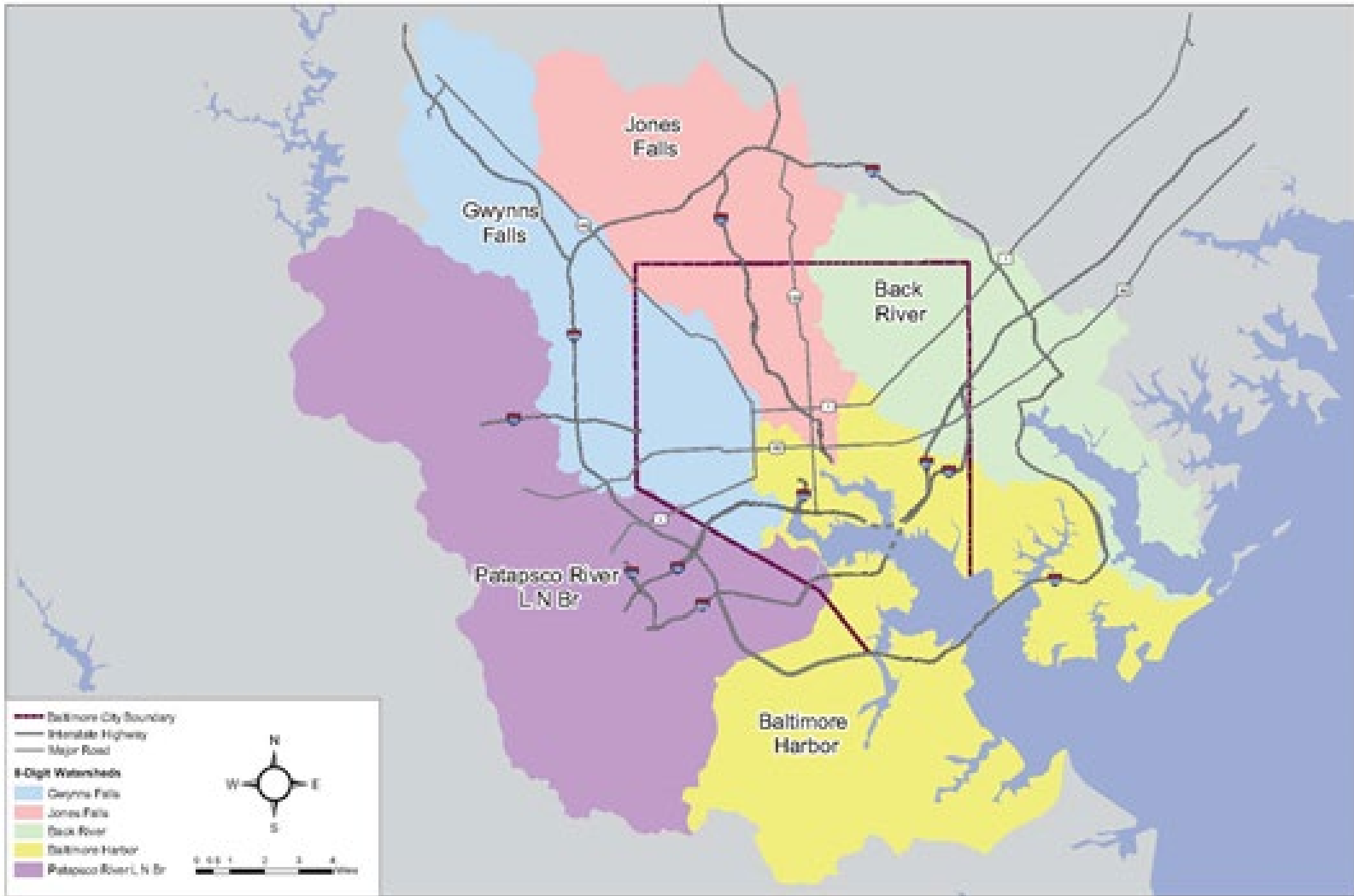

Baltimore City Regulated Floodplain

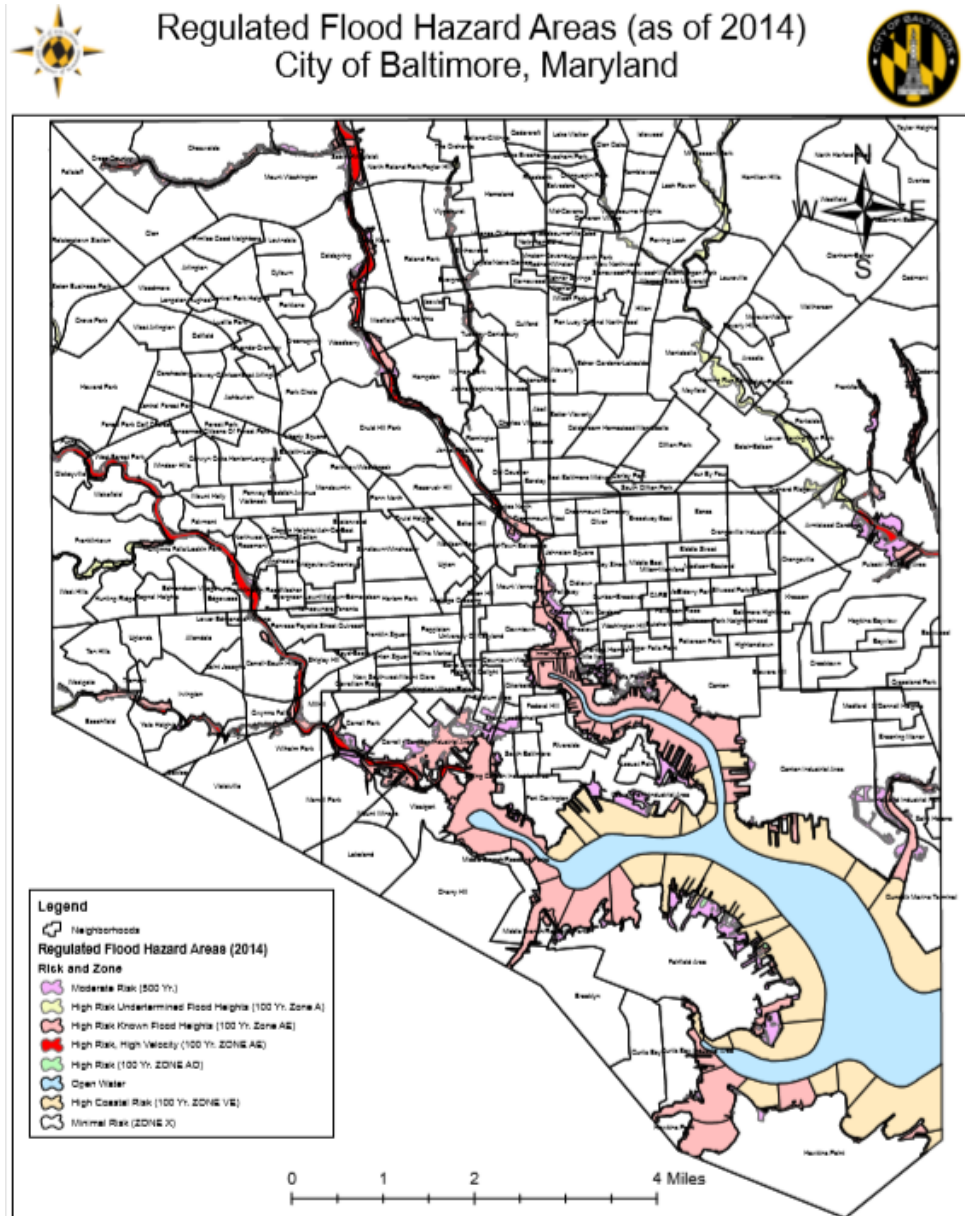

Higher Floodplain Standards

Federal requirement

- Regulate the 1% annual chance of flood areas and elevation of the 1% flood

City of Baltimore

- 1% and 0.2% annual chance of flood areas
 - Geographic range and depth of 0.2% flood area
- Freeboard: additional 2 feet of protection
- Enforcement:
 - Permit system (construction permits)
 - New construction and substantial improvement
 - Permits are required: all construction projects
 - Resilience in mind



Community Rating System (CRS)

- FEMA program
- Rewards jurisdictions that have higher floodplain management requirements
- Baltimore City is part of the CRS program
- Class 10 to Class 1
- Point system: the more we do, the greater the flood insurance discount
- Baltimore is a Class 5:
 - 25% discount in the 1% annual chance of flood area
 - 10% everywhere else in the city



Flood Risk

Baltimore City has tools to help residents define their flood risks:

- Baltimore City CodeMap:
<https://cels.baltimorehousing.org/codemapv2ext/>
- Layer list selection:
Boundaries → City Program Boundaries → Floodplain
- CodeMap will display:
 - Floodplain status (color coded- see legend)
 - Natural grade



Flood Risk

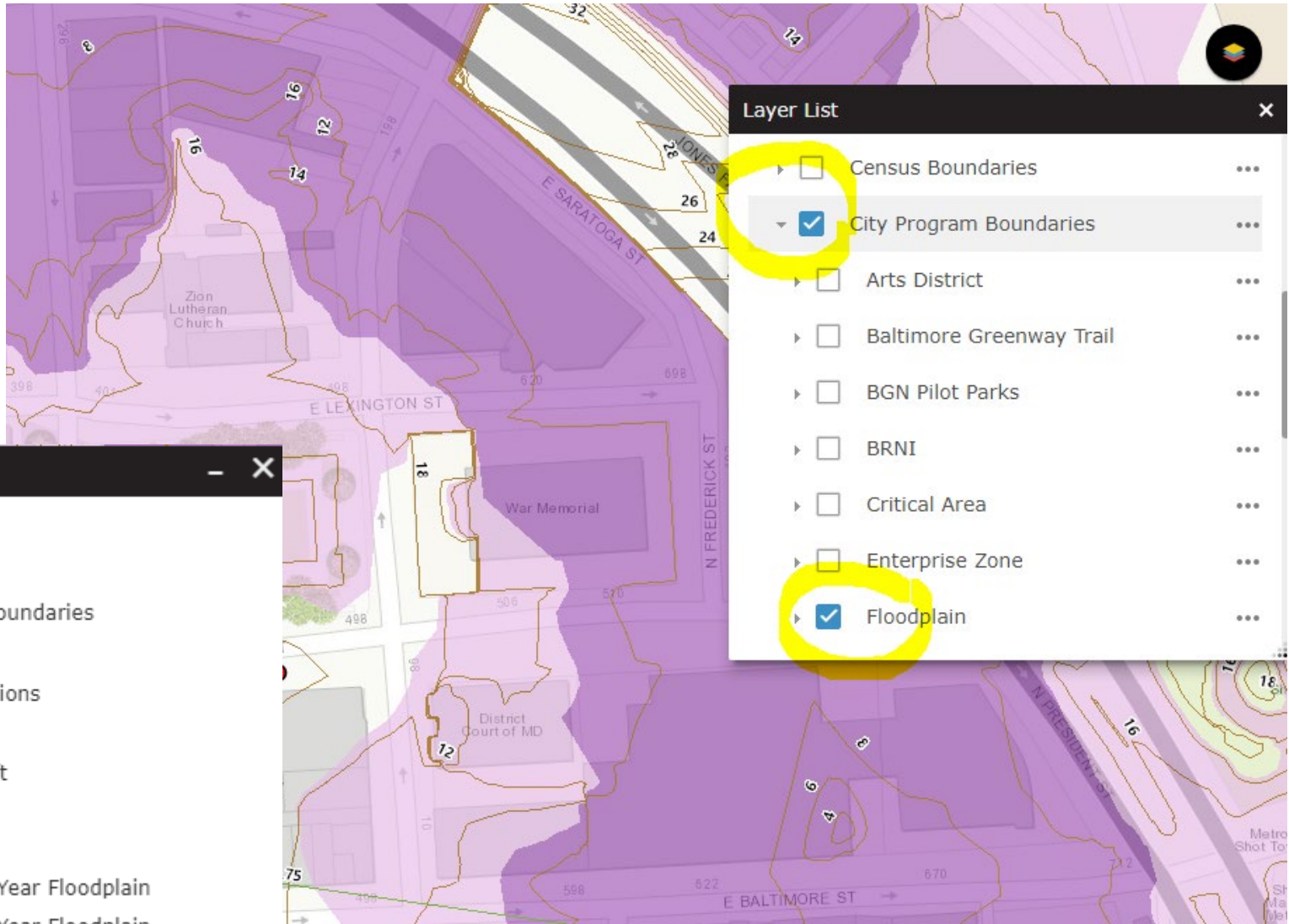

Legend

- Boundaries**
- City Program Boundaries
- Floodplain
 - Cross Sections
 - Contour 2ft
- Floodplain
 - 100 Year Floodplain
 - 500 Year Floodplain
 - Floodway

- ### Layer List
- Census Boundaries
 - City Program Boundaries
 - Arts District
 - Baltimore Greenway Trail
 - BGN Pilot Parks
 - BRNI
 - Critical Area
 - Enterprise Zone
 - Floodplain



Flood Risk

Baltimore City Department of Planning can also help:

- Reach out to the Department of Planning | Office of Sustainability
- A floodplain manager can help you define the flood risk of any property in the city
 - sustainability@baltimorecity.gov
 - (410) 396-7526



Questions & Comments?

Bruna Attila, PMP, CFM, LEED AP

Coastal Planner

Bruna.Attila@baltimorecity.gov





Maryland
Department of
the Environment

Flooding, Flood Mitigation and Flood Insurance

B'more Prepared for Urban Flooding
October 22, 2020

Kevin G. Wagner
Community Assistance Program Manager

About Maryland Department of the Environment (MDE)

- **Mission:** To protect and restore the environment for the health and well-being of all Marylanders.
- **Vision:** Healthy, vibrant and sustainable communities and ecosystems in Maryland.
- **Ben Grumbles**, Secretary
- **Horacio Tablada**, Deputy Secretary



National Flood Insurance Program

- Created by the National Flood Insurance Act of 1968 (Hurricane Betsy, 1965)
- Administered by FEMA/DHS
- Participation is **voluntary**
 - Adopt and enforce regulations
 - Eligible for flood insurance
- **Benefits** of participation:
 - Flood insurance
 - Grants and loans
 - Disaster assistance
 - Federally-backed mortgages
- **Partnership** between the Federal government and the “community” (County or municipal government)



National Flood Insurance Program

Answers to Questions About the NFIP

FEMA F-084 / March 2011



FEMA

Key Components of the NFIP

**Maps and
Data**



**Floodplain
Management &
Mitigation**

Flood Insurance



Maryland
Department of
the Environment

Causes of Flooding in Baltimore

- Stormwater runoff
 - “Urban flooding”
- High tides/coastal storm event (hurricane, Nor’easter)
 - King tide
 - “Nuisance flooding”
 - Sea level rise and land subsidence
- Riverine/flash flood
 - Extreme precipitation
- Other:
 - Water main break
 - Sewer backup



Maryland
Department of
the Environment



Urban Flooding

“...the inundation of property in a built environment, particularly in more densely populated areas, caused by rain falling on increased amounts of impervious surfaces and overwhelming the capacity of drainage systems.”



Nuisance Flooding

“...high tide flooding that causes a public inconvenience.”

Water Main Break



Maryland
Department of
the Environment

Source: CBS. (2009, December 17) *Huge Baltimore Water Main Break* [Video]
YouTube. <https://www.youtube.com/watch?v=5VVj6el8yMk>

Reduce Your Risk – Flood Mitigation

- Use flood damage-resistant materials
- Install flood openings in enclosures
- Install backflow prevention valves
- Elevate HVAC and utilities
- Anchor fuel tanks, extend vent pipe (oil)
- Anchor accessory structures (ex. sheds)
- **FRED – Floodproof, Relocate, Elevate, Demolish**
- **Purchase flood insurance!**



Maryland
Department of
the Environment

Flood Damage-Resistant Materials

- **Acceptable:**
 - Cement board
 - Brick, tile
 - Marine grade plywood
 - Sprayed polyurethane foam insulation
- **Unacceptable:**
 - Gypsum board, greenboard
 - Carpeting
 - Oriented-strand board (OSB)
 - Fiberglass insulation
- **Fasteners and Connectors**
 - Stainless steel or hot-dip galvanized

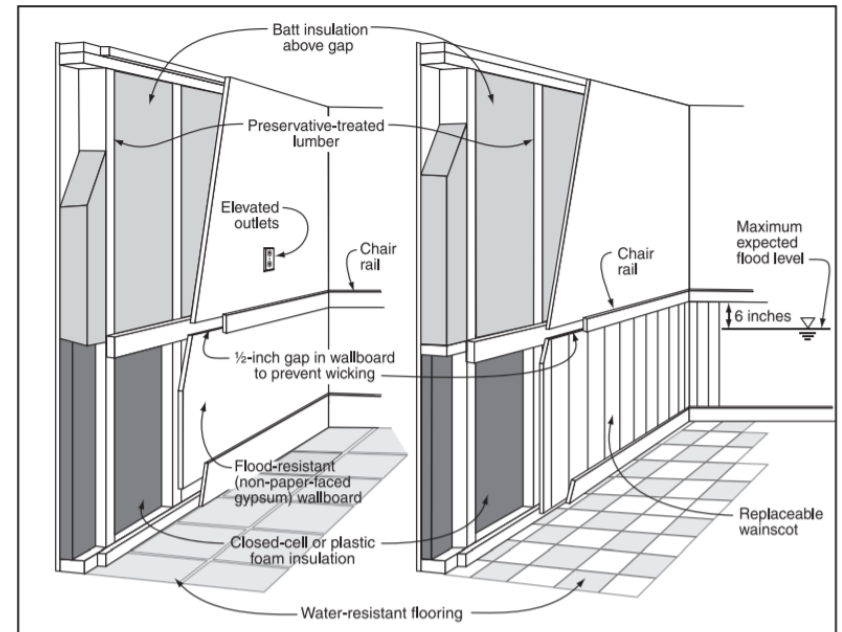

Figure 4. Partial wet floodproofing technique using flood damage-resistant materials for finished wall construction.



Maryland
Department of
the Environment

Flood Openings

- **Reduce hydrostatic pressure on walls**
- Minimum requirements:
 - Bottom of opening must be within 12" of grade
 - 1 square inch of net open area for every square foot of enclosed area OR use engineered openings
 - On at least two different walls



Maryland
Department of
the Environment

Flood Openings

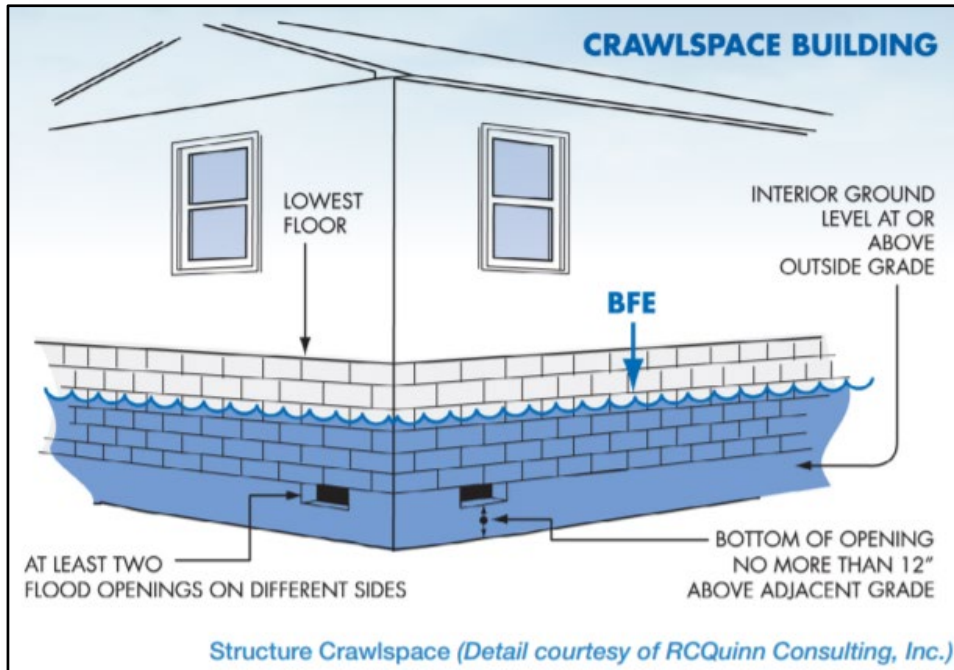

Source: [The American Surveyor, Taking the Mystery Out of Flood Openings, Vol. 10 No. 6](#)

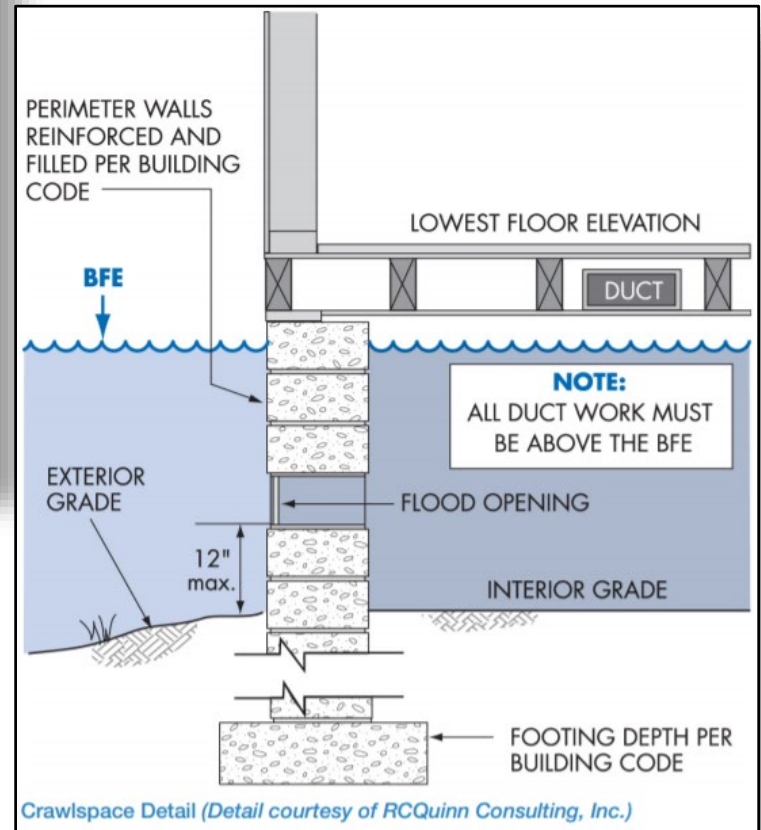

Improper flood openings can result in higher flood insurance!

Backflow Prevention Valve

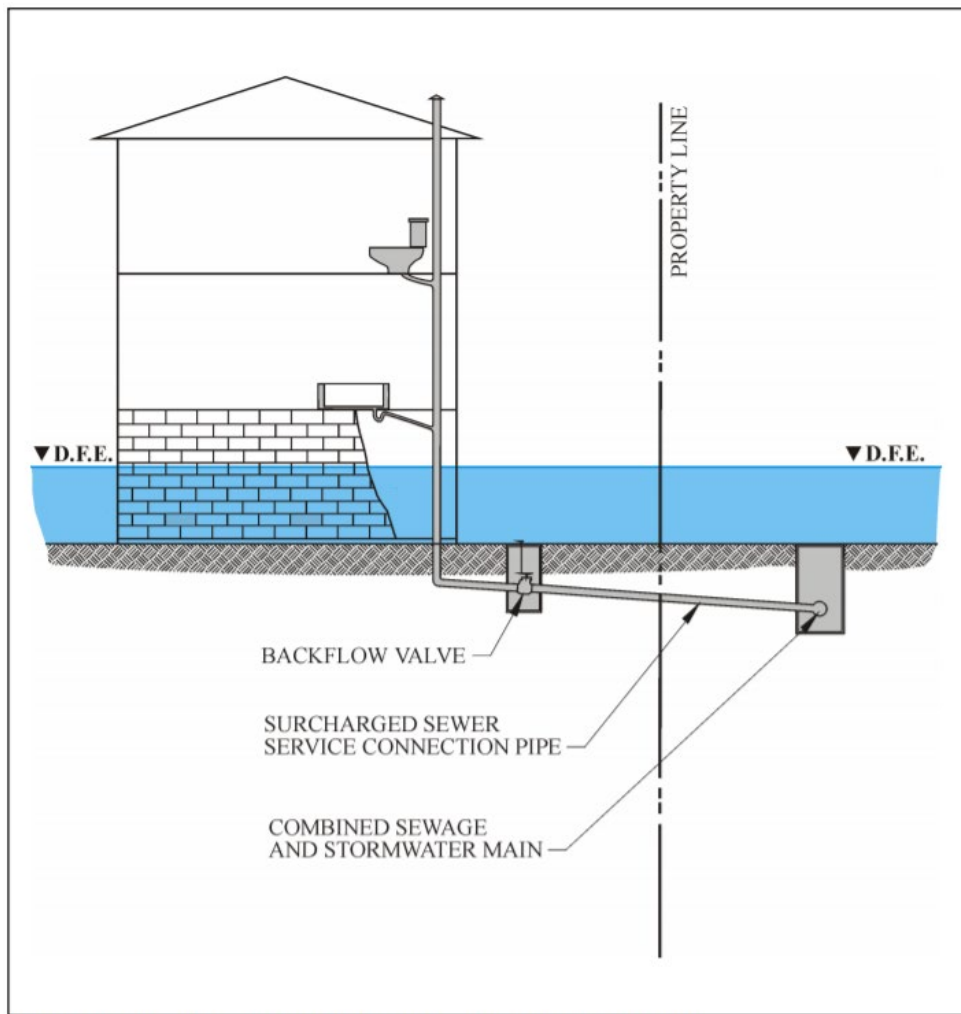

Figure 3.4.4A: Backflow conditions with non-return backflow valve installed

Source: [Protecting Building Utilities From Flood Damage, FEMA-348, November 1999](#)
(has been revised)



Maryland
Department of
the Environment

HVAC Unit & Flood Openings – Dorchester Co.



Maryland
Department of
the Environment

Elevate Utilities

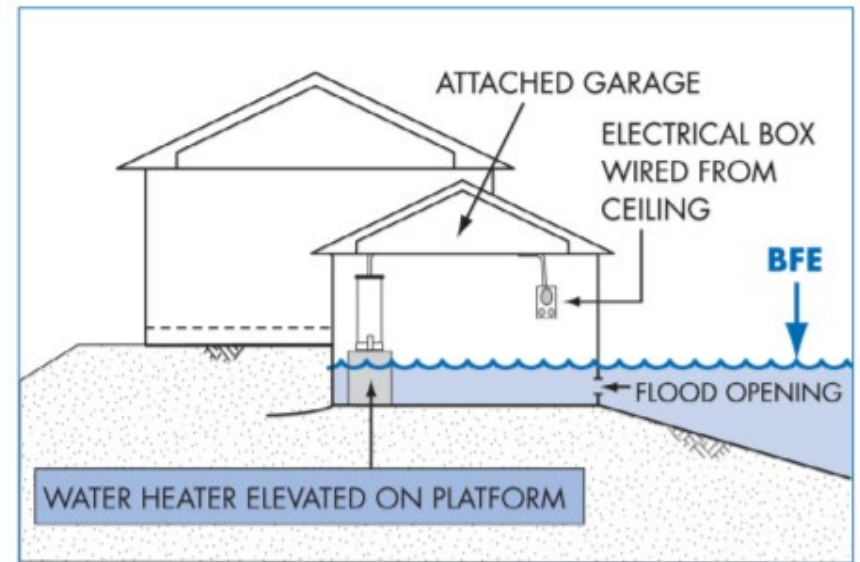
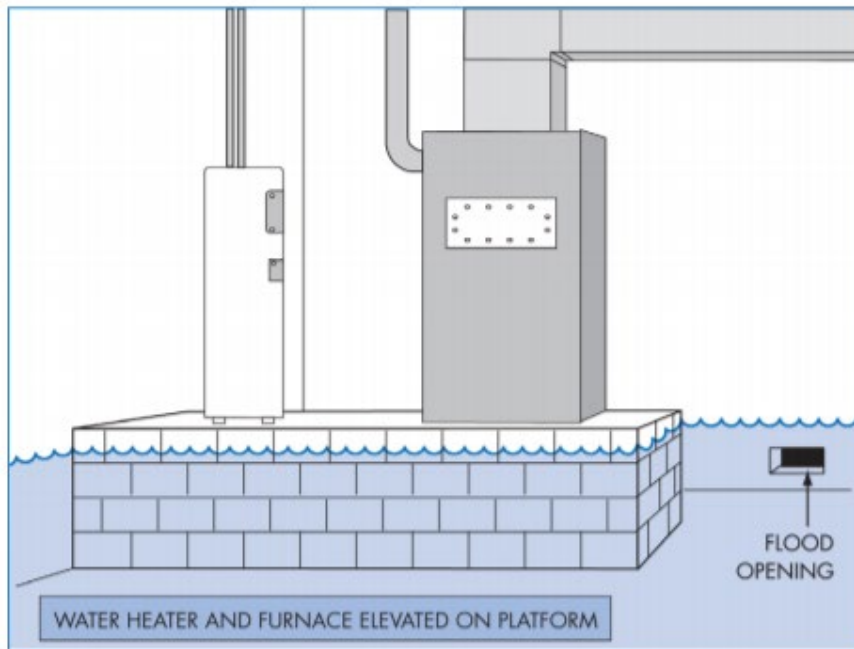

Elevated Utilities (Detail courtesy of RCQuinn Consulting, Inc.)

Non-elevated utilities results in higher flood insurance!

Source: [The American Surveyor, Taking the Mystery Out of Flood Openings, Vol. 10 No. 6](#)



Maryland
Department of
the Environment

Dry Floodproofing Utilities

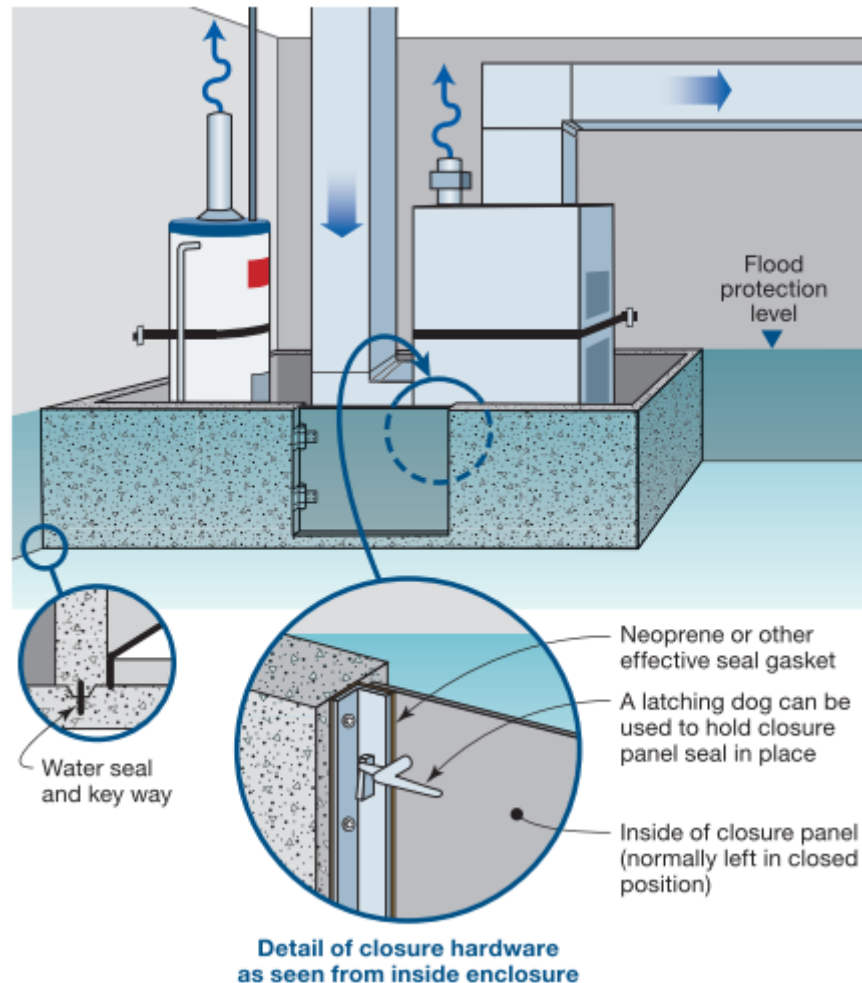

Maryland
Department of
the Environment

Source: [Protecting Building Utility Systems From Flood Damage](#), FEMA P-348, Edition 2, February 2017

Anchoring Fuel Tanks – Inside

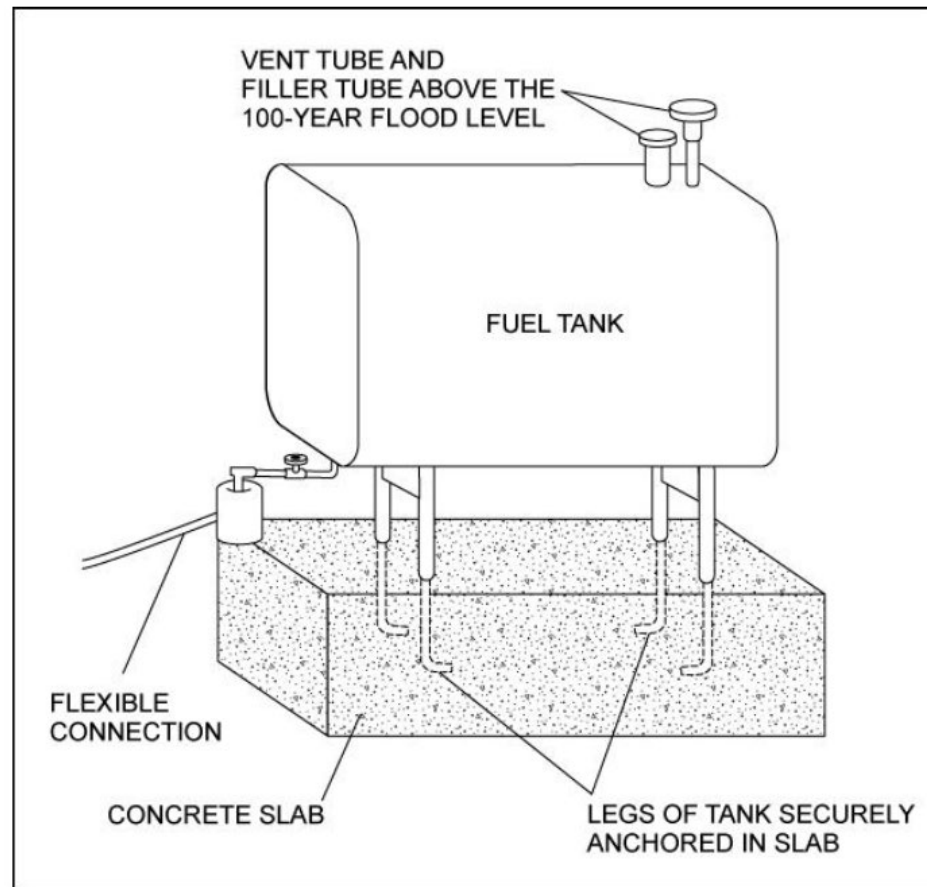

Anchoring a fuel tank.



Maryland
Department of
the Environment

Anchoring a Propane Tank – Outside

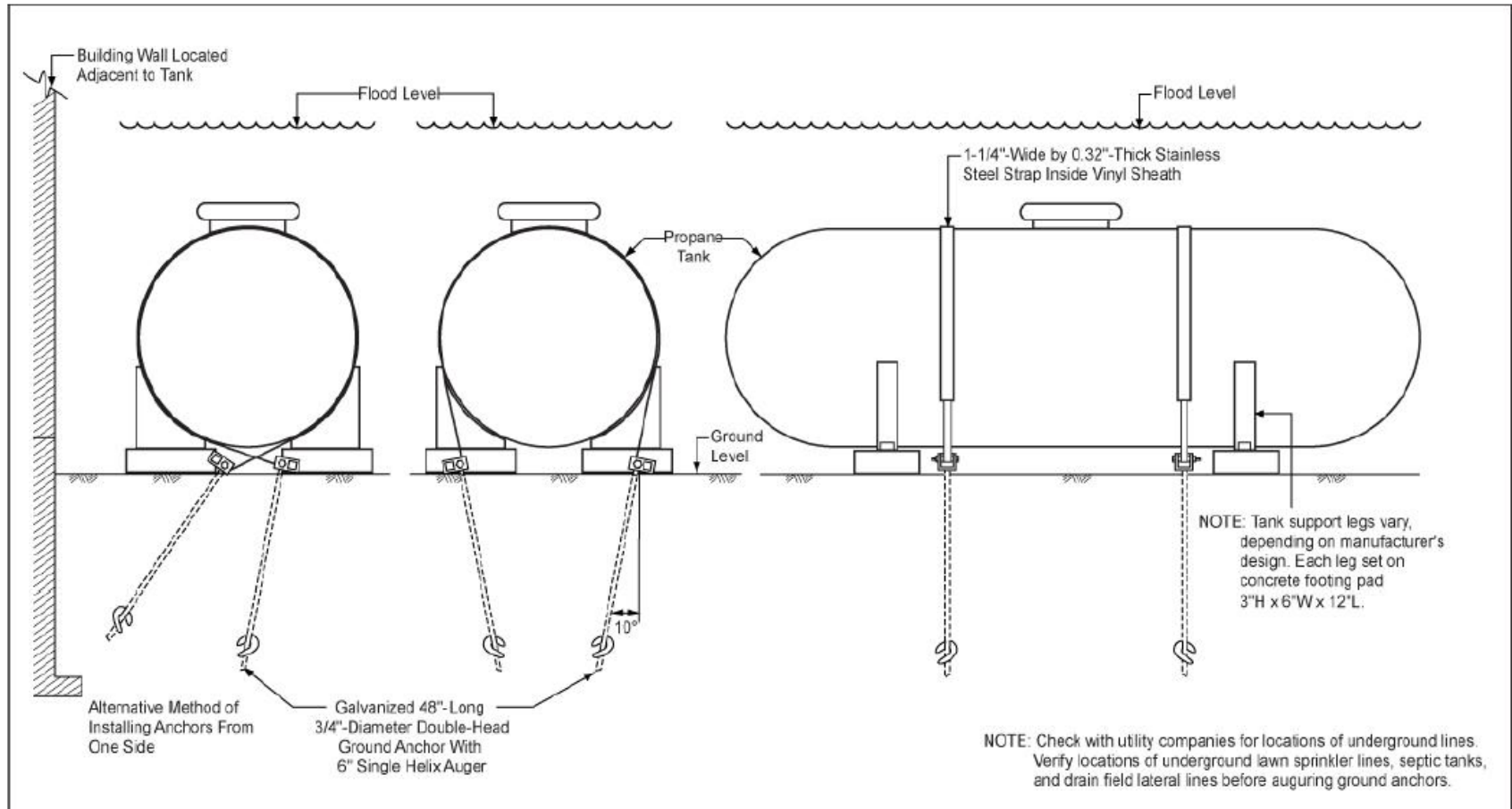

Anchoring an outside propane tank.

Anchoring a Heating Oil Tank – Outside

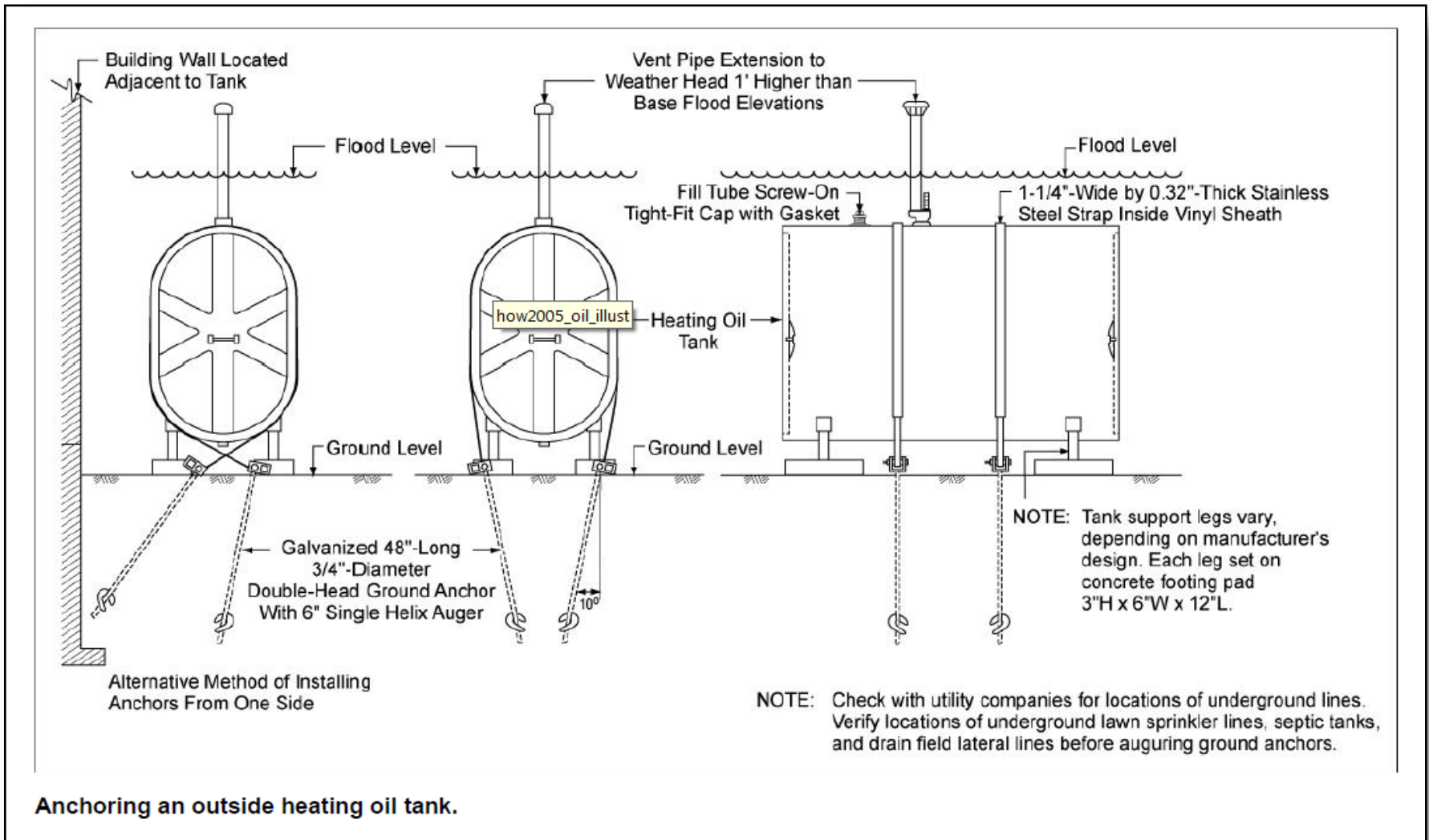

Anchoring an outside heating oil tank.

Accessory Structures

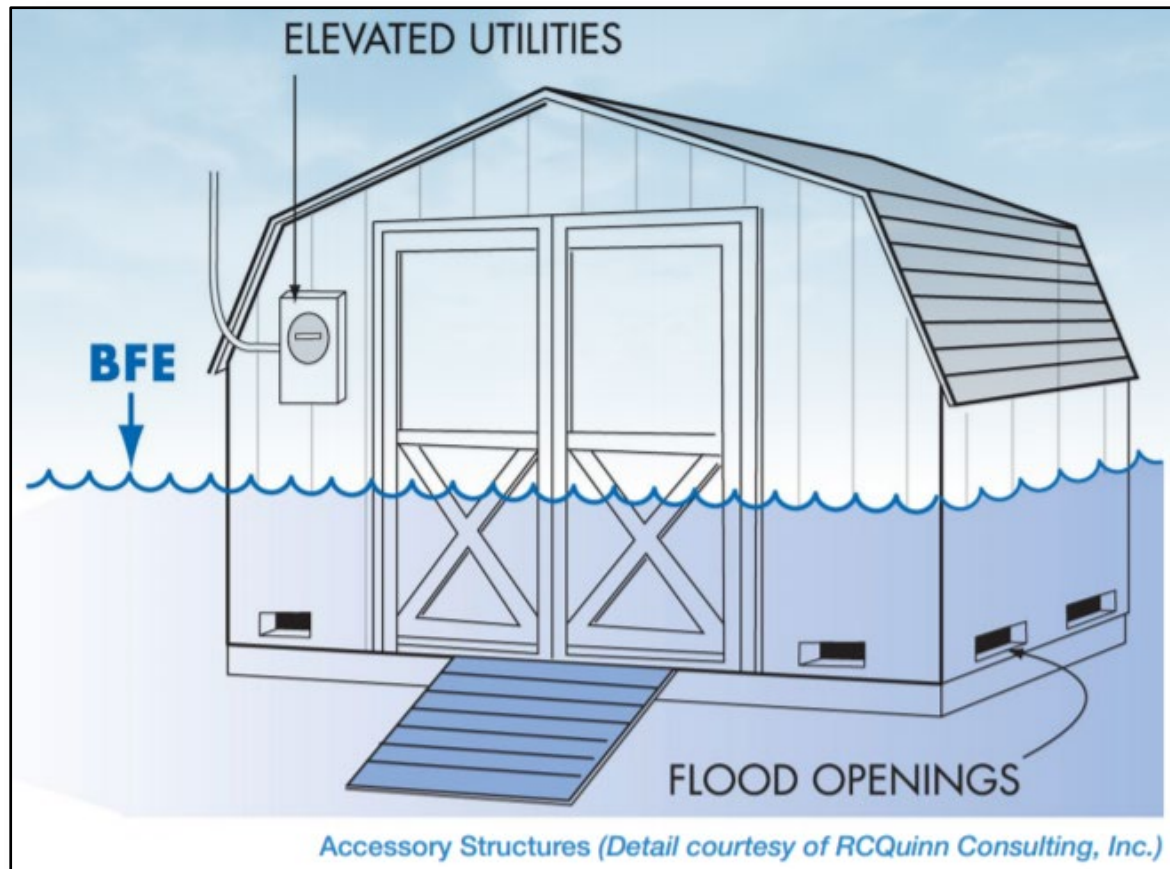

Source: [The American Surveyor, Taking the Mystery Out of Flood Openings, Vol. 10 No. 6](#)



Maryland
Department of
the Environment

Insure Your Risk/Property – Flood Insurance

- **Check with your insurance agent**
- Building and contents coverage
- Available to homeowners, business owners and renters within the community
- Homeowners insurance doesn't usually cover flood damage
- Can purchase even if structure is located outside high risk flood hazard area (Preferred Risk Policy)
- Mandatory purchase requirement for structures in a high risk area with a federally-backed mortgage



Maryland
Department of
the Environment

NFIP Flood Insurance Basics

- Sold by licensed P&C insurance agents through
 - “Write Your Own” insurance companies
 - FEMA’s Direct Servicing Agent
- Essential elements of rating include
 - Flood Zone
 - Elevation Difference (BFE, LFE)
 - Building/Occupancy Type
 - Construction Date (pre-FIRM vs. post-FIRM)
 - Coverage Limits & Deductible

	Emergency Program	Regular Program
Residential (1-4 family)		
Building	\$35,000	\$250,000
Contents	\$10,000	\$100,000
Other Residential		
Building	\$100,000	\$500,000
Contents	\$ 10,000	\$100,000
Non-Residential		
Building	\$100,000	\$500,000
Contents	\$100,000	\$500,000



Flood Insurance

- Flood insurance typically goes into effect 30 days after your purchase.
- Premium is based on several factors:
 - Certain fees and surcharges
 - Year of building construction
 - Building occupancy
 - Number of floors
 - Location of its contents
 - Flood risk (e.g., it's flood zone)
 - Location of the lowest floor in relation to the Base Flood Elevation on the flood map (flood openings will determine)
 - Deductible and amount of building and contents coverage
- A Preferred Risk Policy (PRP) can be purchased for as little as \$325 per year.
- **Read the policy. Know what's covered, and what isn't.**



Maryland
Department of
the Environment

FEMA Publications

- [Protect Your Home from Flooding: Low-Cost Projects You Can Do Yourself](#)
- [Mitigation for Homeowners Fact Sheet](#)
- [NFIP Technical Bulletins](#)
 - 12 bulletins that provide guidance for complying with the NFIP's building performance requirements
 - TB 1: [Requirements for Flood Openings in Foundation Walls and Walls of Enclosures](#)
 - TB 2: [Flood Damage-Resistant Materials Requirement](#)
- [Homeowner's Guide to Retrofitting](#)
- [Protecting Building Utility Systems From Flood Damage](#)



Protect Your Home from Flooding: Low-Cost Projects You Can Do Yourself



- **OUTSIDE THE HOME**
 - Install a rain barrel
 - Elevate utilities and service equipment
 - Anchor outdoor fuel tanks
- **INSIDE THE HOME**
 - Protect your valuable possessions
 - Seal your foundation and basement walls
 - Install food vents
 - Install a sump pump
 - Prevent sewer backups
 - Use food-resistant building materials
 - Raise electrical system components
 - Protect utilities and service equipment
 - Anchor indoor fuel tanks
 - Install a flood alert system



Maryland
Department of
the Environment

Thank you!

- **Kevin G. Wagner**
Community Assistance Program Manager
Maryland Department of the Environment
240-362-2143 (mobile)
kevin.wagner@maryland.gov



Maryland
Department of
the Environment

B'more Prepared for Urban Flooding:

Office of Emergency Management

Thursday, October 22, 2020



B'more Prepared for Urban Flooding

Topics of Discussion:

- The role OEM takes in Baltimore
- BMORE ALERT
- Flood preparedness for renters
- What to do before a flood damages your apartment and what to do if and when flood damage occurs.



B'more Prepared for Urban Flooding

OEM's role in Baltimore

- Provides field response to all major incidents and emergencies around the city on a 24/7 basis.
- Offers logistical and tactile support to first responders during incidents which are complex, widespread and prolonged.
- Develop emergency plans for the city.
- Maintains preparedness among Baltimore's citizens, workers, visitors, and environment to ward off the impact of both natural and man-made emergencies



B'more Prepared for Urban Flooding

BMORE ALERT

- Notification system to send out various emergency, community, and other important alerts to Baltimore residents, businesses and visitors.
- Example Emergency Alerts:
 - Severe weather
 - Extensive flooding
 - Hazardous Chemical release
 - Infectious disease outbreaks
 - Criminal Activity
 - Evacuations



B'more Prepared for Urban Flooding

BMORE ALERT Continued

To register go to:

emergency.baltimorecity.gov/bmore-alert

Member alerts come from either phone number:

866-419-5000 or 855-969-4636

***Alerts can be sent out city-wide or to specific geo-targeted areas.**



B'more Prepared for Urban Flooding

Flood Preparedness for Renters

Prevention & Planning

- Sign up for renters insurance
- Ask your insurance agent about possible insurance discount programs such as the National Flood Insurance Program
- Keep an inventory of items stored in your basement but do not store items there if you wish not to expose them to possible moisture.
- Do not store items on the floor, use shelving units to move items off the floor

*<https://www.homeadvisor.com/cost/disaster-recovery/repair-water-damage/>



B'more Prepared for Urban Flooding

Flood Preparedness for Renters

Flood prevention and planning inside and outside your rental

- Discuss with your landlord:
 - Installing a sump pump (especially if your rental has a basement)
 - Request annual occurring plumbing inspections
 - Report all observed possible points of flooding
 - Photograph flooding as it occurs
- Arrange outdoor landscape away from home, not towards it.
- Check gutters and basement entry drains prior to all anticipated storms and on a regular basis

*<https://www.homeadvisor.com/cost/disaster-recovery/repair-water-damage/>



Clean-Up Actions After A Flood

How to clean up

- Wear PPE to protect yourself prior to entering your home
- Take out, document and toss all flood exposed items which didn't dry out within 24-48 hours
- Open windows and doors to air out your apartment
- Once deemed safe, use fans to help aerate your home.
- Do not mix cleaning products (Especially Bleach and ammonia)
- Clean surfaces with water and detergent
- Remove any visible mold, do not cover it up
- Dry home ASAP
- Get your HVAC system inspected by a professional experienced in mold clean up prior to turning it back on

Page Link Source: <http://www.cdc.gov/mold/cleanup.htm>



Taking Care of Business After A Flood

Get things repaired and get back to life as normal

- Sort items for insurance claims
- Conduct a close review of the terms of your lease
- Document the damage
 - Photograph all damaged items
 - Film a walk-through of your home to establish what damaged accrued to your property vs. the Landlord's property (carpet and walls)
 - Save all items until approved to toss by insurance agency





Understanding Your Insurance Coverage When it Comes to a Disaster

Kejuana Walton

Consumer Education & Advocacy Unit

Kejuana.Walton@Maryland.gov

Agenda

- What is the Maryland Insurance Administration
- How the Maryland Insurance Administration can help
- Coverage to protect you if your automobile sustains a loss due to flooding
- What to do after a loss

What is the Maryland Insurance Administration?

The Maryland Insurance Administration (MIA) is the state agency that regulates the business of insurance in Maryland. The MIA:

- Licenses insurers and insurance producers (agents and brokers)
- Examines the business practices of licensees to ensure compliance
- Monitors solvency of insurers
- Reviews and approves insurance policy forms
- Reviews rates to be sure they are not inadequate, excessive or unfairly discriminatory
- Investigates consumer and provider complaints and allegations of fraud



Maryland
INSURANCE ADMINISTRATION

**EDUCATING &
PROTECTING
CONSUMERS**



How can the Maryland Insurance Administration help?

If you feel that your insurer or insurance producer acted improperly, you have the right to file a complaint. The MIA can investigate complaints that an insurer or insurance producer has:

- Denied or delayed payment of all or portions of a claim
- Improperly terminated your insurance policy
- Raised your insurance premiums without proper notice or in excess of what the law allows
- Made false statements to you in connection with the sale of insurance or the processing of insurance claims
- Overcharged you for services, including premium finance charges

Do you have the right automobile coverage?

When it comes to auto insurance coverage, **Comprehensive Coverage** provides you the coverage for property damage to your insured vehicle resulting from occurrences other than collision.



- Flooding
- Theft
- Vandalism



- Glass breakage not resulting from an accident
- A vehicle striking an animal

If you have only liability coverage, your insurer will not pay for the above types of damage or for damage to your vehicle from a collision.

Do You Have the Right Automobile Coverage?

Review your policy to determine what is covered and what is excluded. If you are not clear about coverage speak to your insurer or insurance producer.

You may want to ask these questions:

- What types of damage are covered?
- How long will it take to process my claim?
- Will I need to obtain estimates for repairs?
- Will filing a claim under my comprehensive coverage raise my premium?

Comprehensive Coverage

- 1 **POLICY PERIOD** When coverage begins and ends.
- 2 **POLICY LIMITS** The most your policy will pay for each claim that is filed.
- 3 **DEDUCTIBLE** What you pay for damage to your vehicle when you file a claim with your insurance company.
- 4 **OPTIONAL COVERAGE** Optional coverage sometimes may be purchased to give you more protection. Ask your agent about any optional coverage available.
- 5 **POLICY PREMIUM** The amount you pay for insurance coverage for the policy period.
- 6 **COUNTS** Your company may reduce your premium if you meet conditions that are set by the company. For example, if you have a good driving record, your car has anti-theft devices, or you have your automobile and homeowners

Your Insurance Company
3535 Second Street
Company Town, USA 54321

Policy number: XX-XXXXXX-XX
Policy period: 6 months
Effective date: January 1, 2015
Expiration date: July 1, 2015

Auto Insurance Policy <SAMPLE>

Year	Make	Model	Vehicle ID Number (VIN)
2011	Chevrolet	Camaro	2FZMPONW34XB56094

Lienholder
The Bank
310 Main Street
Company Town, USA

Coverages	Policy limits	Deductibles
Liability: Bodily injury	\$30,000 per person \$60,000 per accident	Collision \$500 Comprehensive \$100
Liability: Property damage	\$15,000 per accident	
Uninsured/Underinsured motorist	\$30,000 per person \$60,000 per accident	Policy premium \$640
Personal injury protection (PIP)	\$2,500	Discounts applied
Optional coverage	Limits	Multiple vehicle Home/Auto/Life Mature driver Claim record/Customer longevity Air bags/Anti-lock brakes Premium paid in full
Roadside assistance	\$100 per occurrence	
Rental car reimbursement	\$30 per day \$1,000 maximum	

Your policy consists of this page, any endorsements and the policy form. Keep together.

Comprehensive coverage has a **deductible** that is shown on your policy's **declarations page**.

Your policy provides a certain period of time for you to notify the insurer of your claim.



200 St. Paul Place, Suite 2700
Baltimore, MD 21202
410-468-2000
800-492-6116
800-735-2258 TTY
www.insurance.maryland.gov



Car damaged by a flood?

If your vehicle has suffered flood damage, it is important to file your claim as soon as you can. It is a good idea to also:

- ✓ take photographs or video of the damage
- ✓ take all of the necessary steps to prevent mold or mildew from developing in your car. For example, you can properly dry out your vehicle to prevent mold and mildew. Your insurer may choose to pay for a cleaning before looking to see if there is any flood damage that needs to be repaired.

Car damaged by a flood?



- Your insurer may tell you to take your vehicle (or have your vehicle towed) to a body shop where you will receive an estimate of the amount of damage to the vehicle.
- You have the right to select the repair facility where your vehicle will be repaired.
 - Your insurer may send an adjuster to assess the damage.



If the car floated away, you can contact the police department to see if your car has been recovered.



If a tree or limbs have fallen on your car, this damage would also likely be covered under your comprehensive coverage subject to any applicable deductible.

If the tree is on the property of another, such as a neighbor or on public land, the owner of the tree will generally not be responsible for the damage unless the tree was a hazard prior to the loss and the owner should have known and failed to take action.



What happens if your insurer decides that your vehicle is a total loss?

If you purchased comprehensive coverage and your vehicle is determined to be a total loss, your insurer will make a **settlement offer reflecting the actual cash value (ACV) of the vehicle immediately prior to the loss.**

You will be responsible for payment of your deductible.

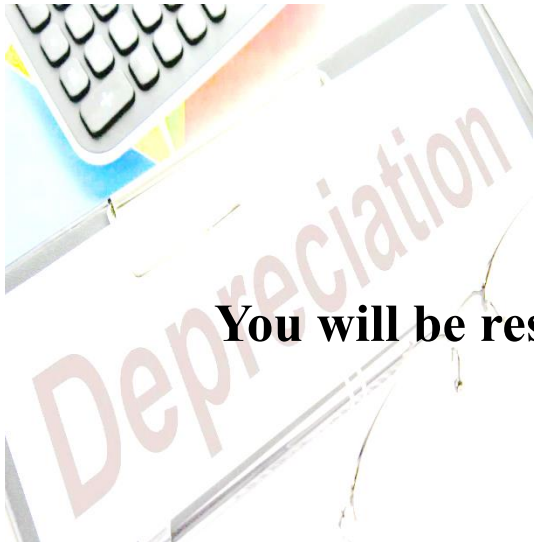

What if my vehicle is a total loss?

- **Total Loss** - the cost to repair the vehicle is **75 percent or greater than the fair market value of the vehicle immediately prior to the loss.**
- Your insurer is permitted to add **additional costs such as the cost of a rental vehicle and potential hidden damage to the cost to repair your vehicle when calculating the 75 percent value.**

What if my vehicle is a total loss?

- ✓ Your insurer generally has 10 days to offer a cash settlement to you. The insurer must include all applicable taxes and registration fees in the cash settlement offer.
- ✓ The offer from the insurer must be an amount that reflects the retail value for a “substantially similar motor vehicle” using a nationally recognized valuation manual or computerized data bank, or a quotation for a substantially similar motor vehicle from a qualified dealer at a location reasonably convenient to the claimant.



What if my vehicle is a total loss?

You may request the following in writing from the insurer:

- ✓ Settlement offer
- ✓ Explanation of the method used to arrive at the offer
- ✓ Detailed explanation of the calculation of the motor vehicle's total loss value, including the calculation of any value added to the motor vehicle by options
- ✓ A list of all the deductions that will be made from the value of the motor vehicle.
- ✓ A copy of the inspection guidelines relied on to determine the condition of the vehicle at the time of the loss.

The insurer is required by law to respond within seven business days of your request.

Settlement Offer



If you think your car is worth more than what the insurer offered, you can negotiate with your insurer. It's important to know that you must provide supporting documentation for your counteroffer. You can do this by getting quotes from car dealers or viewing prices and ads online for similar vehicles.

Reminder



- If your insurer denies any part of your claim, be sure they put the denial in writing and you keep a copy of all the paperwork.
- Insurers consider loss history and claim frequency when making decisions on whether they will insure you, renew your policy and the cost of your policy.

Contact Information

Maryland Insurance Administration

1-800-492-6116 or 410-468-2000

www.insurance.maryland.gov

Publications Available on MIA's Website

Check out the following publications for more information.

- An Insurance Preparedness Guide for Natural Disasters
- A Consumer Guide to Disaster-Relief Resources
- Consumer Guide to Homeowners Insurance
- Why Renters Insurance is a Good Idea
- Consumer Guide to Auto Insurance
- Property Damage – What to Do After A Loss
- Weather Related Damage – Frequently Asked Questions about Insurance Coverage
- An Insurance Preparedness Guide For Post-Disaster Claims





EMERGENCY PREPAREDNESS

Baltimore City Health Department Preparedness Workshop



Bernard C. "Jack" Young
Mayor, Baltimore City
Letitia Dzirasa, M.D.
Commissioner of Health, Baltimore City

@Bmore_Healthy 
BaltimoreHealth 
health.baltimorecity.gov

The Time To Prepare Is NOW

The Next Event Will Happen
It Is Only A Matter Of Time



Bernard C. "Jack" Young,
Mayor, Baltimore City
Letitia Dzirasa, M.D.
Commissioner of Health, Baltimore City

 **BALTIMORE
CITY HEALTH
DEPARTMENT**

Create Your Plan

Talk About Your Plan With
Close Relative or Friend



Bernard C. "Jack" Young,
Mayor, Baltimore City
Letitia Dzirasa, M.D.
Commissioner of Health, Baltimore City

 **BALTIMORE
CITY HEALTH
DEPARTMENT**

Connect With Other Seniors There is Strength in Numbers

- Connect and share information with other seniors where you live.
- Determine how you will get to an alternate location in the event you have to evacuate. You can partner with friends, family members or other seniors



Bernard C. "Jack" Young,
Mayor, Baltimore City
Letitia Dzirasa, M.D.
Commissioner of Health, Baltimore City

Personal Preparedness Plan

Emergency Plan

- Create a personal preparedness plan in the event you have to shelter-in-place at home, or evacuate to an alternate location

Emergency Kit

- Pick up a few items each time you go to the grocery. Make emergency kits for your home and keep one in your vehicle



Bernard C. "Jack" Young,
Mayor, Baltimore City
Letitia Dzirasa, M.D.
Commissioner of Health, Baltimore City

 **BALTIMORE
CITY HEALTH
DEPARTMENT**

Personal Emergency Kit

9 ESSENTIALS IN AN
EMERGENCY KIT

B'MORE PREPARED

BALTIMORE CITY HEALTH DEPARTMENT
Office of Public Health Preparedness and Response
1001 E. Fayette Street
Baltimore, MD 21202
www.baltimorehealth.org

A simple guide to the
nine essential items to help
you shelter-in-place in the
event of an emergency.

Plan



1. WATER
2. FOOD
3. CLOTHES
4. MEDICATIONS
5. FLASHLIGHT
6. CAN OPENER
7. RADIO
8. HYGIENE ITEMS
9. FIRST AID



Bernard C. "Jack" Young,
Mayor, Baltimore City
Letitia Dzirasa, M.D.,
Commissioner of Health, Baltimore City

BALTIMORE
CITY HEALTH
DEPARTMENT

Personal Emergency Kit

B'MORE PREPARED

BALTIMORE CITY HEALTH DEPARTMENT
Office of Public Health Preparedness and Response
1001 E. Fayette Street
Baltimore, MD 21202
www.baltimorehealth.org

A simple guide to the nine essential items to help you shelter-in-place in the event of an emergency.



WATER

The recommended amount is 1 Gallon per person per day for 3 days.

COVID caused a number of items to fly off the shelves earlier this year. it would be best to increase your water supply to last 2 weeks or more If you can.



Bernard C. "Jack" Young,
Mayor, Baltimore City
Letitia Dzirasa, M.D.
Commissioner of Health, Baltimore City



Personal Emergency Kit

B'MORE PREPARED

BALTIMORE CITY HEALTH DEPARTMENT
Office of Public Health: Preparedness and Response
1001 E. Fayette Street
Baltimore, MD 21202
www.baltimorehealth.org

A simple guide to the nine essential items to help you shelter-in-place in the event of an emergency.



FOOD

Include canned and dry goods. You do not have to purchase all of these items at the same time. Pick a few items up each time you go to the store.



Bernard C. "Jack" Young,
Mayor, Baltimore City
Letitia Dzirasa, M.D.
Commissioner of Health, Baltimore City

Personal Emergency Kit

B'MORE PREPARED

BALTIMORE CITY HEALTH DEPARTMENT
Office of Public Health: Preparedness and Response
1001 E. Fayette Street
Baltimore, MD 21202
www.baltimorehealth.org

A simple guide to the
nine essential items to help
you shelter-in-place in the
event of an emergency.



CLOTHES AND FOOTWEAR

Include a complete change of clothes and sturdy footwear and rainwear in your kit.



Bernard C. "Jack" Young,
Mayor, Baltimore City
Letitia Dzirasa, M.D.,
Commissioner of Health, Baltimore City

BALTIMORE
CITY HEALTH
DEPARTMENT

Health Information Card

ABOUT YOU	<p>Fill out this card with help from your healthcare provider. Fold it up along the dotted lines and keep it with you in your wallet, purse, or other safe place.</p> <p>Name: _____</p> <p>Phone Number: _____</p> <p>Address: _____</p> <p>_____</p> <p>Birth Date: _____</p> <p>Blood Type: _____</p> <p>Primary Language Spoken: _____</p> <p>_____</p>	<p>Allergies (medicine, food or other):</p> <p>_____</p> <p>_____</p> <p>_____</p> <p>Medical Conditions (such as asthma, diabetes, epilepsy, heart condition, high blood pressure, lung problems, kidney disease, chronic hepatitis, HIV infection):</p> <p>_____</p> <p>_____</p> <p>_____</p> <p>Special Needs (hearing, speaking, seeing, moving):</p> <p>_____</p> <p>_____</p> <p>Special Equipment / Supplies / Other Needs:</p> <p>_____</p> <p>_____</p>	<p>EMERGENCY CONTACTS</p> <p>1st Emergency Contact</p> <p>Name: _____</p> <p>Phone: _____</p> <p>2nd Emergency Contact (someone who lives out of town)</p> <p>Name: _____</p> <p>Phone: _____</p> <p>Email: _____</p> <p>Other Important Numbers (doctors, service providers)</p> <p>_____</p> <p>_____</p> <p>_____</p>	<p>IN AN EMERGENCY:</p> <p>Follow your emergency plan and instructions from local officials.</p> <p>Keep this important information with you.</p> <p>Take medicines and important supplies with you if you have to leave your home.</p> 	Health Information Card
------------------	---	---	--	--	--------------------------------

YOUR MEDICINE RECORD

Write all of the prescription and over-the-counter drugs, vitamins, and herbal supplements that you take. Keep this list up to date (cross out medicines you no longer take). Fill it out with the help of your doctor, pharmacist, or other care provider. Take your medicine how it is prescribed. Prepare to take medicine with you in an emergency.

MEDICINE	DOSE	WHEN DO YOU TAKE IT?	PURPOSE
Name of medication and strength	How many pills, units, puffs, drops per dose?	How many times a day? Morning and night? After meals?	Why do you take it?
_____	_____	_____	_____
_____	_____	_____	_____
_____	_____	_____	_____
_____	_____	_____	_____
_____	_____	_____	_____
_____	_____	_____	_____
_____	_____	_____	_____
_____	_____	_____	_____
_____	_____	_____	_____
_____	_____	_____	_____

Adopted from Philadelphia Department of Public Health



Bernard C. "Jack" Young,
Mayor, Baltimore City
Letitia Dzirasa, M.D.
Commissioner of Health, Baltimore City



Health Information Card

Keep a Copy Meds On Your Fridge

- Medical personnel may need to retrieve it off of your fridge in the event of an emergency.
- Keep a copy with you and one in your emergency kit.



Bernard C. "Jack" Young,
Mayor, Baltimore City
Letitia Dzirasa, M.D.
Commissioner of Health, Baltimore City

 **BALTIMORE
CITY HEALTH
DEPARTMENT**

Write down frequently called numbers

This is in the event your cell phone breaks or your batteries run down

Keep one list with you; place one on your fridge and one in your kit



Bernard C. "Jack" Young,
Mayor, Baltimore City
Letitia Dzirasa, M.D.
Commissioner of Health, Baltimore Cit

BALTIMORE
CITY HEALTH
DEPARTMENT

Personal Emergency Kit

B'MORE PREPARED

BALTIMORE CITY HEALTH DEPARTMENT
Office of Public Health Preparedness and Response
1001 E. Fayette Street
Baltimore, MD 21202
www.baltimorehealth.org

A simple guide to the nine essential items to help you shelter-in-place in the event of an emergency.



Manual Can Opener, Flashlight, Radio and First Aid Kit.

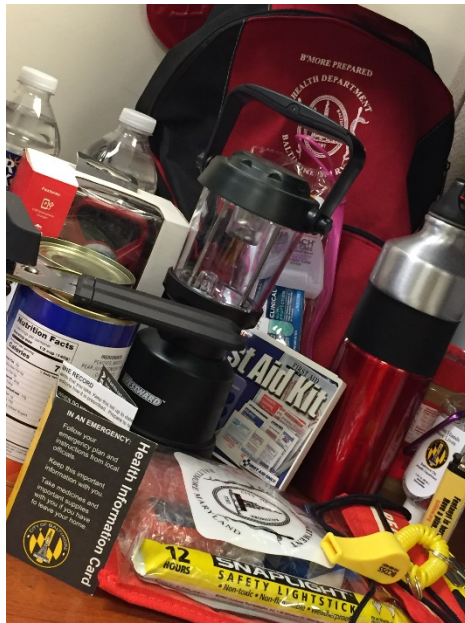

- Include extra batteries
- Check flashlights and radio regularly
- Keep a flashlight in every room
- Add first aid items ahead of time so you will have them when you need them



Bernard C. "Jack" Young,
Mayor, Baltimore City
Letitia Dzirasa, M.D.
Commissioner of Health, Baltimore City

BALTIMORE
CITY HEALTH
DEPARTMENT

Other Important Items

B'MORE PREPARED

BALTIMORE CITY HEALTH DEPARTMENT
Office of Public Health Preparedness and Response
1001 E. Fayette Street
Baltimore, MD 21202
www.baltimorehealth.org

A simple guide to the nine essential items to help you shelter-in-place in the event of an emergency.



Hearing Aids and Other Devices

- Plan for hearing aids and other special medical devices
- Include extra batteries
- Have alternate places you can get your special need items in the event of an emergency



Bernard C. "Jack" Young,
Mayor, Baltimore City
Letitia Dzirasa, M.D.
Commissioner of Health, Baltimore City

Communication



Keep A Copy of Important Documents

- Keep one with you; place one on your fridge and one in your kit
- Charge your cell phones each night
- Keep an extra charger with you
- Cell phones may not work in a large scale emergency. Know where there is a Land Line or Pay Phone.



Bernard C. "Jack" Young,
Mayor, Baltimore City
Letitia Dzirasa, M.D.
Commissioner of Health, Baltimore City

 **BALTIMORE
CITY HEALTH
DEPARTMENT**

Communication



Keep A Copy of Important Documents and List Of Important Numbers

- Make a copy of important documents; give one to a trusted friend or relative and put another in a safe place for retrieval later.
- Determine how you will contact friends and loved ones in the event of an emergency.



Bernard C. "Jack" Young,
Mayor, Baltimore City
Letitia Dzirasa, M.D.
Commissioner of Health, Baltimore City

 **BALTIMORE
CITY HEALTH
DEPARTMENT**

Brain Teasers and Other Items

Add crossword puzzles, cards, coloring books to your kit

- A little distraction goes a long way during an emergency.
- Adding these items ahead of time means that you don't have to wish you had them later.



Bernard C. "Jack" Young,
Mayor, Baltimore City
Letitia Dzirasa, M.D.
Commissioner of Health, Baltimore City

 **BALTIMORE
CITY HEALTH
DEPARTMENT**

Finally-Be Safe

Be aware of your surroundings

- Keep cell phone use to a minimum if you walking outside
- Know where exits are when you go into a building.
- Know alternate routes to and from your destination.



Bernard C. "Jack" Young,
Mayor, Baltimore City
Letitia Dzirasa, M.D.
Commissioner of Health, Baltimore City

 **BALTIMORE
CITY HEALTH
DEPARTMENT**





Thank you for your time!

*Contact Bridget Wright at
Bridget.wright@baltimorecity.gov
if you have any questions.*



*Bernard C. "Jack" Young,
Mayor, Baltimore City
Letitia Dzirasa, M.D.
Commissioner of Health, Baltimore City*

@Bmore_Healthy 
BaltimoreHealth 
health.baltimorecity.gov

Questions?

Baltimore City Department of Planning

Bruna Attila, Coastal Planner

bruna.attila@baltimorecity.gov

Maryland Department of the Environment

Kevin Wagner, Community Assistance Program Manager

kevin.wagner@maryland.gov

Baltimore City Office of Emergency Management

Crystal Bright, Deputy Preparedness Section Chief

crystal.bright@baltimorecity.gov

Maryland Insurance Administration

Kejuana Walton, Consumer Education & Advocacy Unit Outreach Staffer

kejuana.walton@maryland.gov

Baltimore City Health Department

Bridget Wright, Community Health Educator

bridget.wright@baltimorecity.gov